

4-Pin Amber LED Lamp (7.6 mm)

OVFSAAC8

- Packaged in tubes
- Compatible with automatic placement equipment
- Compatible with infrared and vapor phase reflow solder process
- Mono-color type
- Pb-free

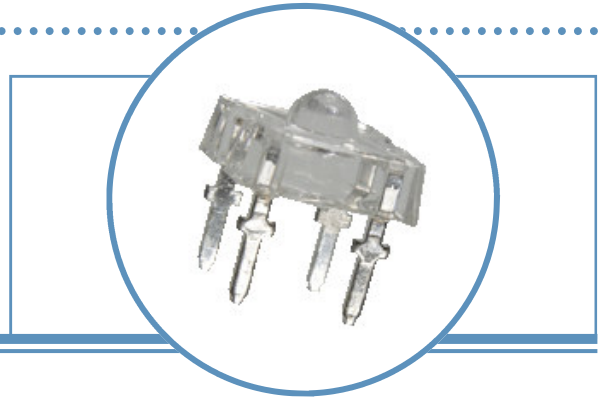

The **OVFSAAC8** is designed with higher forward voltage to maximize brightness and incorporates a low-profile lens to enhance efficient light distribution. Response time is fast and it consumes less power resulting in low current requirements from circuit power supply. Tubular arrays replace neon in outdoor and indoor signs. This square package allows high-density arrays to form light engines.

Applications

- Automotive: Rear stop/turn signal lamps/truck marker lamps
- Mood-setting decoration and landscape lighting
 - Special decorative interior/exterior lighting
 - Special effects stage lighting
- Illumination for signs and channel letters
- Traffic signals, pedestrian and walkway signs

Part Number	Material	Emitted Color	Flux Typ. mlm	Lens Color
OVFSAAC8	AllnGaP	Amber	5000	Water Clear

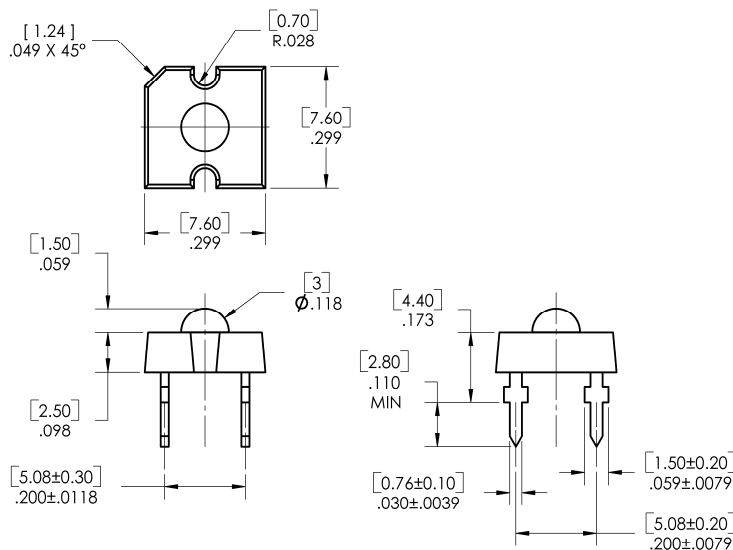

DIMENSIONS ARE IN INCHES AND [MILLIMETERS].

DO NOT LOOK DIRECTLY AT LED WITH UNSHIELDED EYES OR DAMAGE TO RETINA MAY OCCUR.

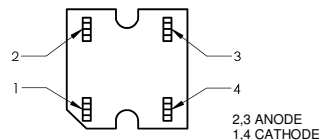
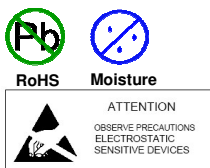

OPTEK reserves the right to make changes at any time in order to improve design and to supply the best product possible.

4-Pin Amber LED Lamp

OVFSAAC8



Absolute Maximum Ratings

$T_A = 25^\circ\text{C}$ unless otherwise noted

Storage Temperature Range	-40 ~ +100°C
Operating Temperature Range	-40 ~ +100°C
Lead Soldering Temperature (3 mm from the base of the epoxy bulb) ¹	260°C
Reverse Voltage	5 V
Continuous Forward Current ²	70 mA
Peak Forward Current (10% Duty Cycle, PW ≤ 100 μsec)	200 mA
Power Dissipation	210 mW

Notes:

- Solder time less than 5 seconds at temperature extreme.
- Heat sink is adequate if the device is operated at ambient temperature higher than 25°C. For long term performance the drive currents between 10 mA and 50 mA are recommended. Please contact an Optek sales representative for more information on recommended drive conditions.

Electrical Characteristics

$T_A = 25^\circ\text{C}$ unless otherwise noted

SYMBOL	PARAMETER	MIN	TYP	MAX	UNITS	CONDITIONS
lumen	Luminous Flux	3000	5000	----	mlm	$I_F = 70\text{ mA}$
V_F	Forward Voltage	----	2.5	3.0	V	$I_F = 70\text{ mA}$
I_R	Reverse Current	----	----	100	μA	$V_R = 5\text{ V}$
λ_D	Dominant Wavelength	584	591	599	nm	$I_F = 70\text{ mA}$
$2\theta_{1/2}$	50% Power Angle	----	100	----	deg	$I_F = 70\text{ mA}$

Standard Bins ($I_F = 70\text{ mA}$)

Lamps are sorted to luminous flux (Φ_V), forward voltage (V_F), and dominant wavelength (λ_D) bins shown. Orders for OVFSAAC8 may be filled with any or all bins contained as below.

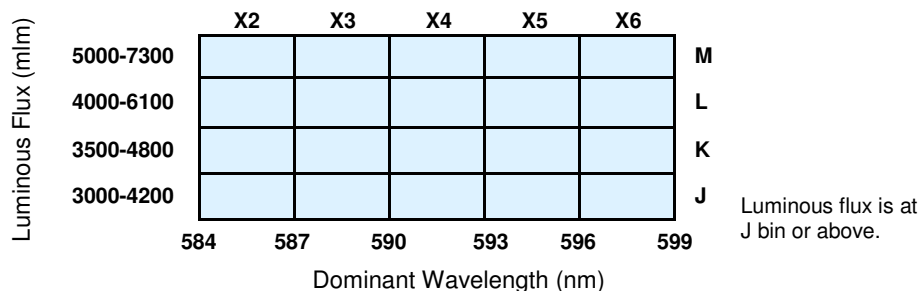

Forward Voltage (V_F)

Rank	V3	V4	V5	V6	V7
Voltage (V)	2.0–2.2	2.2–2.4	2.4–2.6	2.6–2.8	2.8–3.0

Important Notes:

- All ranks will be included per delivery, rank ratio will be based on the chip distribution.
- To designate luminous intensity ranks, please contact OPTEK.

OPTEK reserves the right to make changes at any time in order to improve design and to supply the best product possible.

Typical Electro-Optical Characteristics Curves

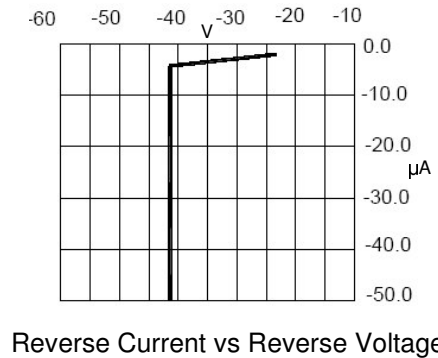
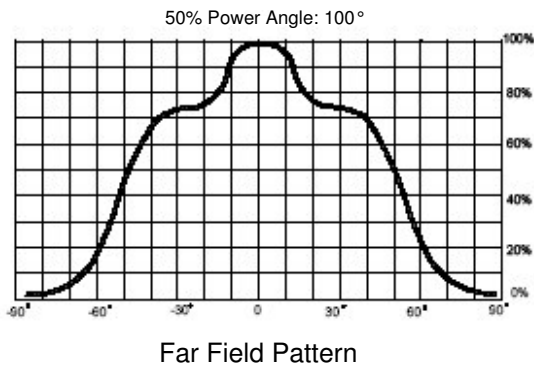
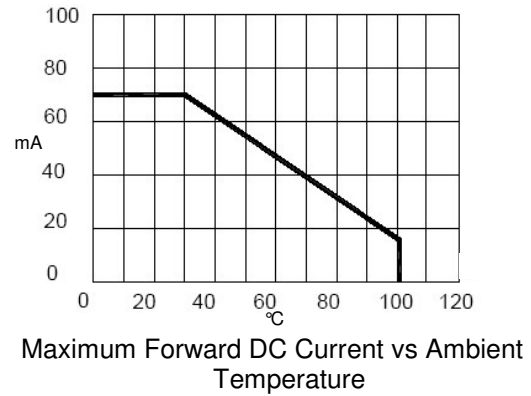
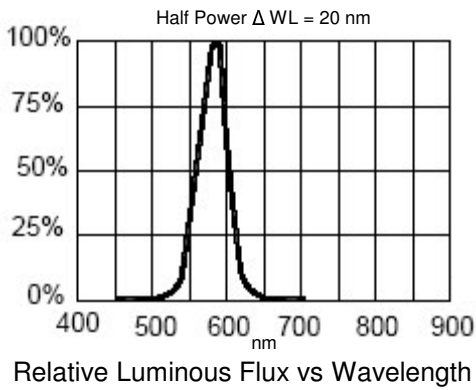
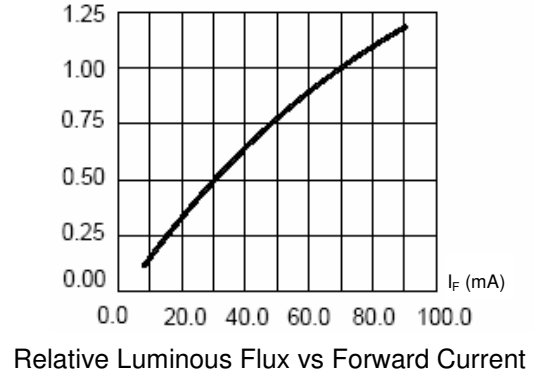
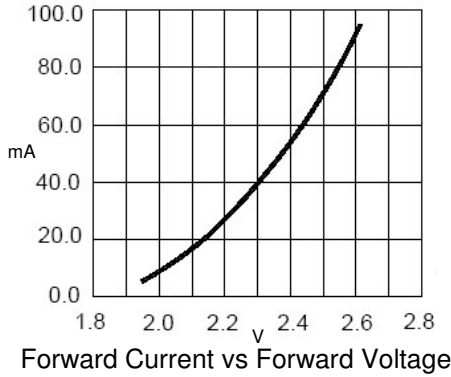

OPTEK reserves the right to make changes at any time in order to improve design and to supply the best product possible.

Moisture Resistant Packaging

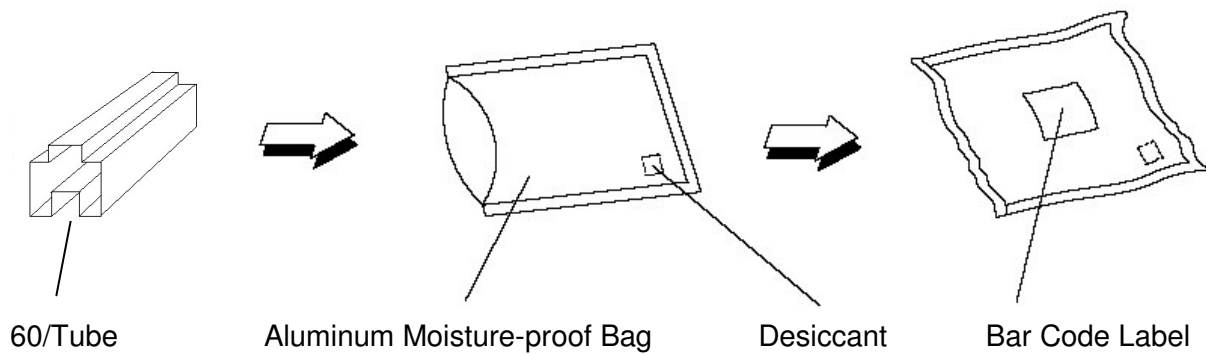

OPTEK reserves the right to make changes at any time in order to improve design and to supply the best product possible.